



Présentation d'entreprise p 4 - 5

Liste des Rals p 6

Principe du bioclimatique p 7

Pergolas p 8 - 25

Bélize - pergola à lames orientables

Panama - pergola à lames orientables

Castille - pergola à toiture fixe

Carports p 28 - 38

C150

C210

Brise soleil p 40 - 41



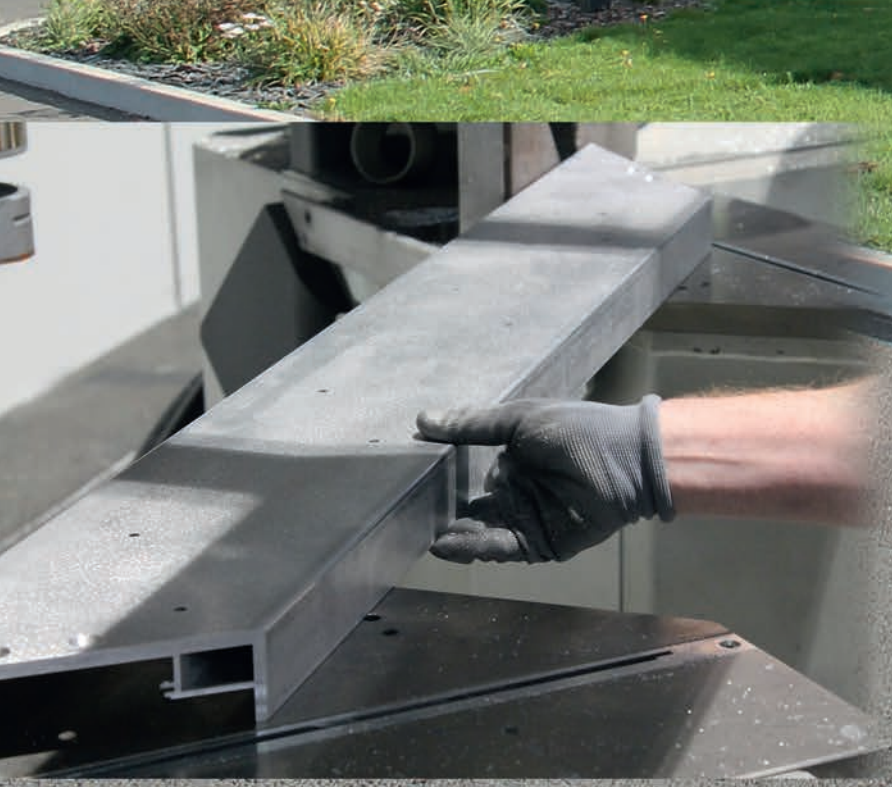



Avec Oriasun, profitez pleinement de vos extérieurs sous votre pergola, protéger votre véhicule grâce à nos carports ou bien apporter de l'ombre avec notre brise-soleil.

Spécialiste de l'aluminium, bénéficiez d'une fabrication Française et de tout notre savoir-faire.

Notre engagement qualité sera assuré de la conception à la livraison pour répondre aux plus hautes exigences.

Standards structure :

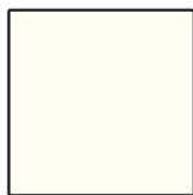

Blanc
9010
mat



Gris
7016
sablé

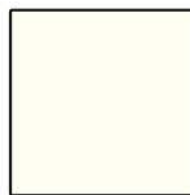

Blanc
9010
mat

Standards lames :

S u r m e s u r e :



Vert
6005
sablé



Vert
6009
sablé



Vert
6021
sablé



Gris
7024
sablé



Gris
7035
sablé



Brun
8014
sablé



Brun
8019
sablé



Noir
9005
sablé



Blanc
9016
sablé



Ivoire
1015
sablé



Rouge
3004
sablé



Bleu
5003
sablé

*Profitez de vos extérieurs tout le temps
par tous les temps !*

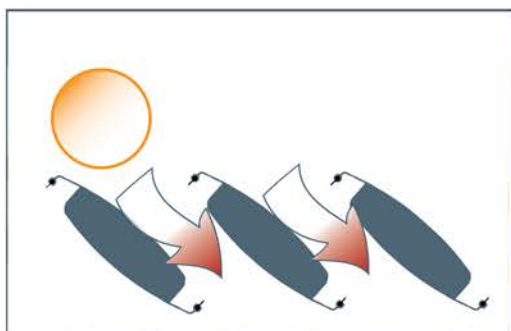

**Par temps frais,
laissez entrer la chaleur**

G é r e z l ' e n s o l e i l l e m e n t

Gérez librement l'orientation des lames, pour profiter pleinement du soleil ou pour créer une zone d'ombrage

Profitez de votre terrasse tout au long de l'année, grâce à nos pergolas.

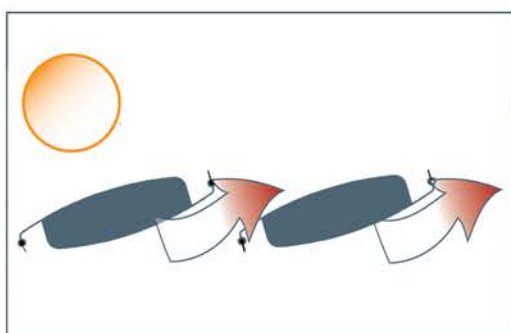

**Evacuez la chaleur,
pour éviter un effet de serre**

V e n t i l a t i o n N a t u r e l l e

Evitez l'effet de serre, en créant un mouvement d'air naturel.

L'air chaud s'évacue par l'ouverture des lames et permet une ventilation efficace

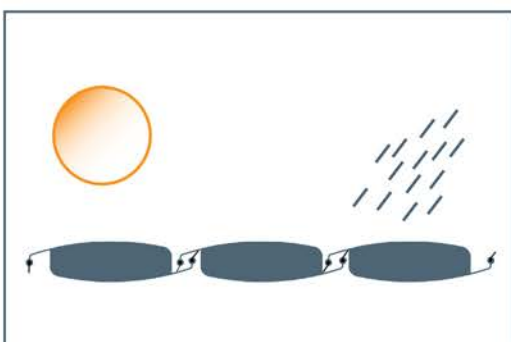

**Protection contre la pluie
et les rayons du soleil**

P r o t e c t i o n c o n t r e l a p l u i e e t l e s r a y o n s d u s o l e i l .

Lorsque les lames sont fermées, nos pergolas sont étanches de lames à lames et vous protègent efficacement contre les intempéries.

L'évacuation de l'eau se fait par les gouttières puis par les poteaux.

Attention, nos pergolas ne sont pas hors d'eau, hors d'air telle une véranda





Le Bioclimatique simplement



Protection contre les rayons du soleil et la pluie



Par temps frais, Laissez entrer la chaleur



Evacuez la chaleur, pour éviter un effet de serre

Manoeuvre des lames

Par manivelle Magnétique

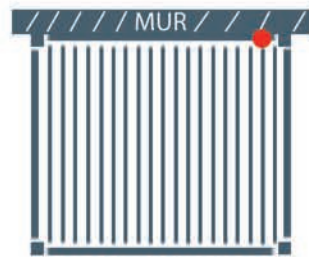

Vue de dessus

Dimensions

4,13x3,50 mètres / 5,18x3,50 mètres
(Murale ou Autoportante)
Hauteur : 2,50m

Sur mesure max : 10,36 x 3,50m (2 modules)
hauteur max : 3m

Coloris

Structure: Blanc 9010 mat

Gris 7016 sablé

Lames: Blanc 9010 mat

 Sur mesure uniquement structure (selon RAL disponible p.6)

Options



Eclairage par bandeau LED couleurs



Store zippé enroulable manuel

DES PROFILS ROBUSTES ET ESTHETIQUES :

Cadre

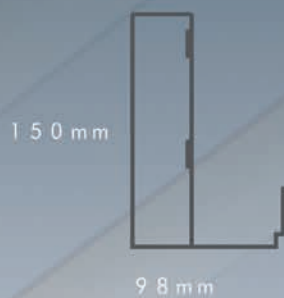

EP. 2,5mm

Poteau



EP. 4mm

Lame



EP. 1,5mm

FIXATION MURALE

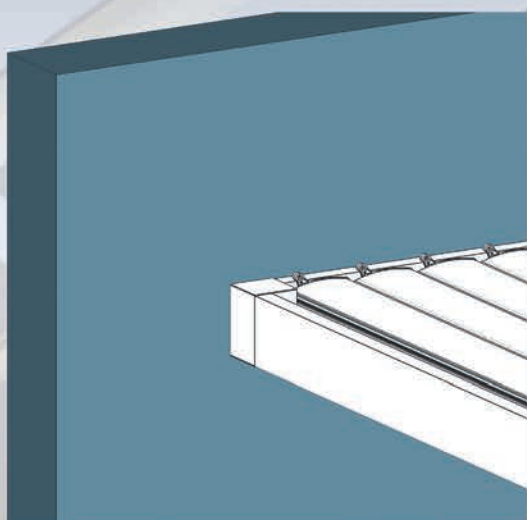

FIXATION DE POTEAUX invisible



FIXATION DE POTEAUX Semi-débordante

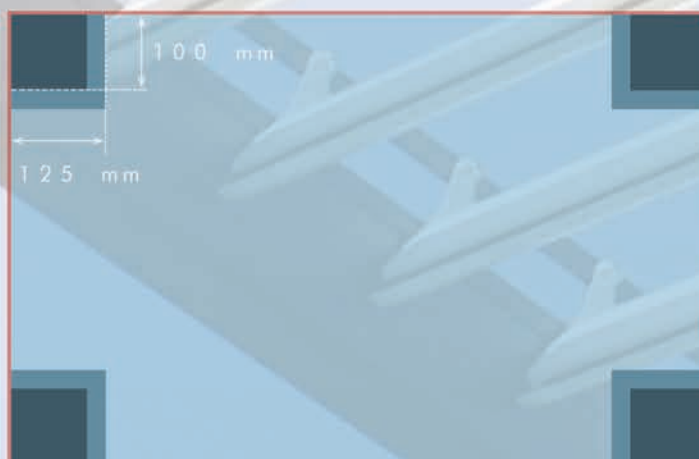
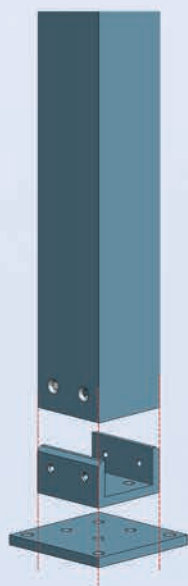

Les 2 types de fixation sont incluses dans toutes nos pergolas Marbella

EXEMPLES DE CONFIGURATIONS :



4,13 x 3,50m
Autoportante

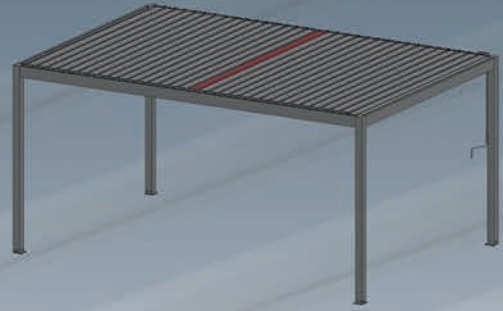

5,18 x 3,50m
Autoportante

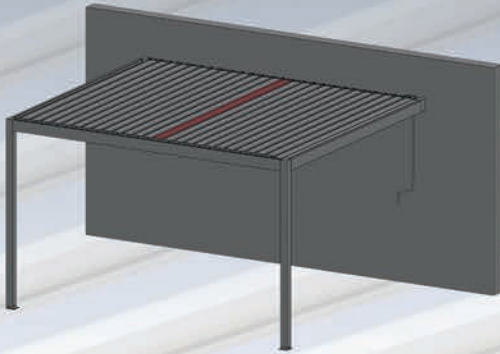

4,13 x 3,50m
Murale

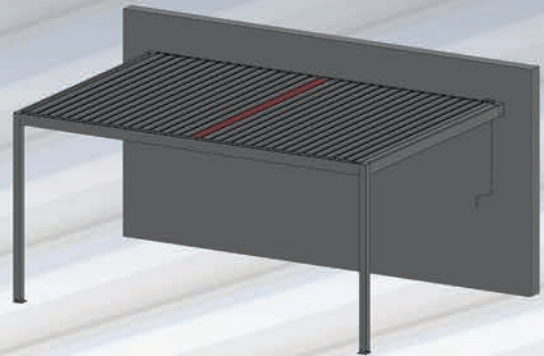

5,18 x 3,50m
Murale

Lame fixe pour les pergolas d'une largeur mini 3380 mm.

Hauteur : 2,50m Hauteur lames ouvertes/hors tout: 2,56m

EXEMPLES D'ASSEMBLAGES

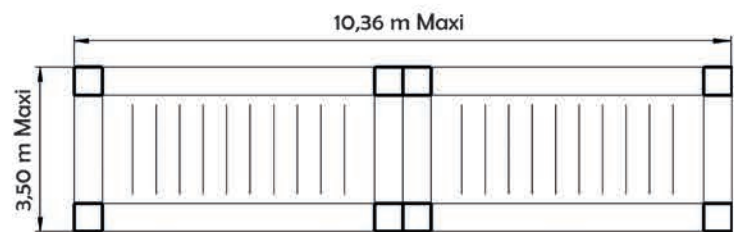
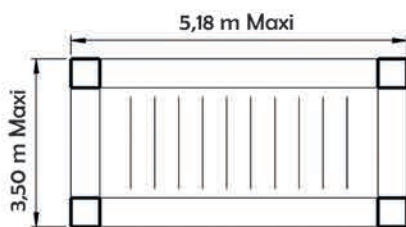

LES OPTIONS :

Eclairage LED



LED RGB 230/24 V

Structure : Flexible

Puissance : 14,4 watts/mètre
4000 K
1270 lm

Indice de protection : IP67



Télécommande avec roue chromatique

- Radio Fréquence
- IP 44
- Contrôle des couleurs tactile
- Réglage de l'intensité

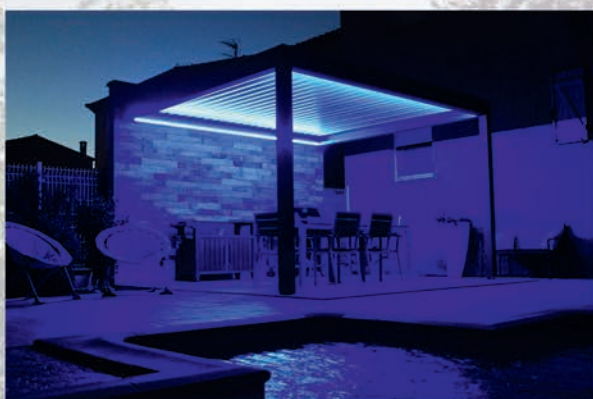
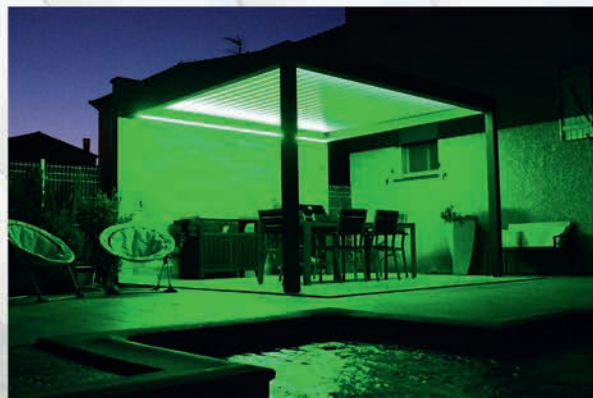
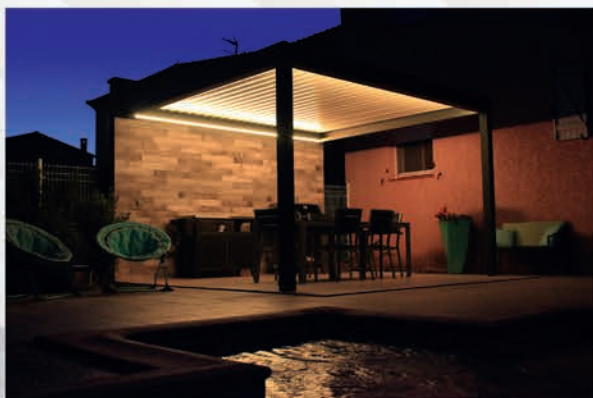

LES OPTIONS :

Store zippé manuel 



Grammage de la toile : 525g/m²

Epaisseur : 0,75mm

Température : -30°C / +70°C

Coloris



Gris clair



Gris foncé



Blanc

Store façade en 2 parties avec poteau intermédiaire pour les pergolas d'une largeur supérieur à 4279mm (hors tout)

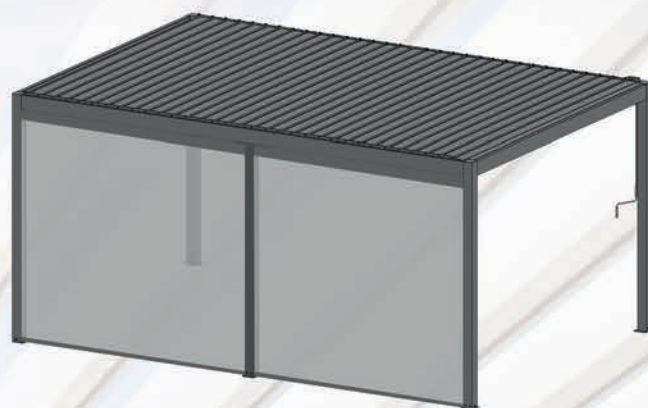
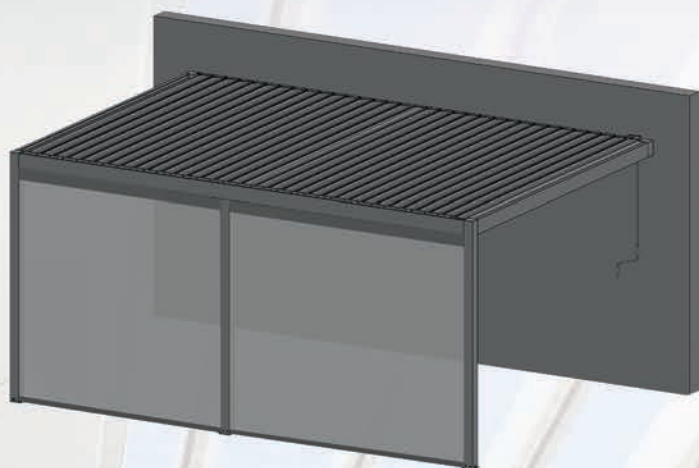

Cales de réglages

Vous permet de mettre votre pergola de niveau

Disponible en lots de 6 cales :

- 6 cales de 5mm
- 6 cales de 10mm

Hauteur de calage Max : 30mm





Le Bioclimatique haut de gamme



Protection contre les rayons du soleil et la pluie



Par temps frais, Laissez entrer la chaleur



Evacuez la chaleur, pour éviter un effet de serre

Manoeuvre des lames

Par vérin électrique et télécommande

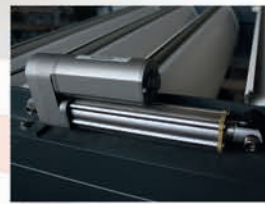

Cache-vérin

Dimensions

3x3 mètres / 4,05x3 mètres / 6x3 mètres
(Murale ou Autoportante)
Hauteur : 2,50m

Sur mesure max: 6x6m sans poteau intermédiaire
possibilité d'assembler plusieurs Panama
hauteur max: 3m

Coloris

Structure: Blanc 9010 mat

Gris 7016 sablé

Lames: Blanc 9010 mat

 Sur mesure
uniquement structure
(selon RAL disponible p.6)

Options



Eclairage par bandeau LED couleurs



Paroi coulissante verre



Capteur vent/pluie/neige/gel



Store zippé enroulable motorisé

DES PROFILS ROBUSTES ET ESTHÉTIQUES :

Cadre



EP. 2,5 mm

Poteau



EP. 5 mm

Closoir poteau



EP. 1,5 mm

Lame



EP. 1,5 mm

Nous assurons l'étanchéité entre lames à l'aide de deux joints (epdm) Une légère pente assure l'évacuation de l'eau vers les poteaux

FIXATION MURALE

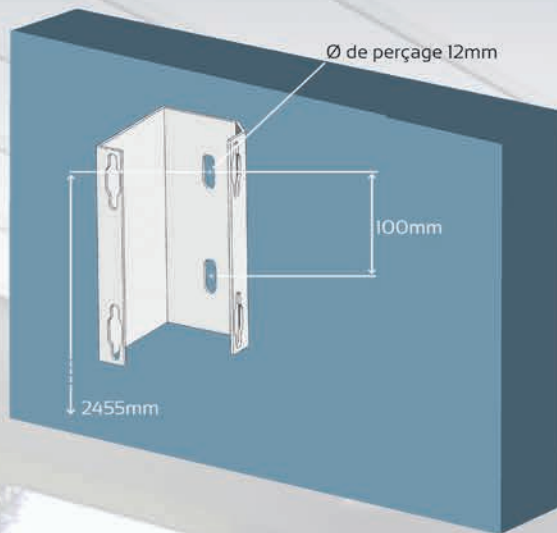

FIXATION DES POTEAUX

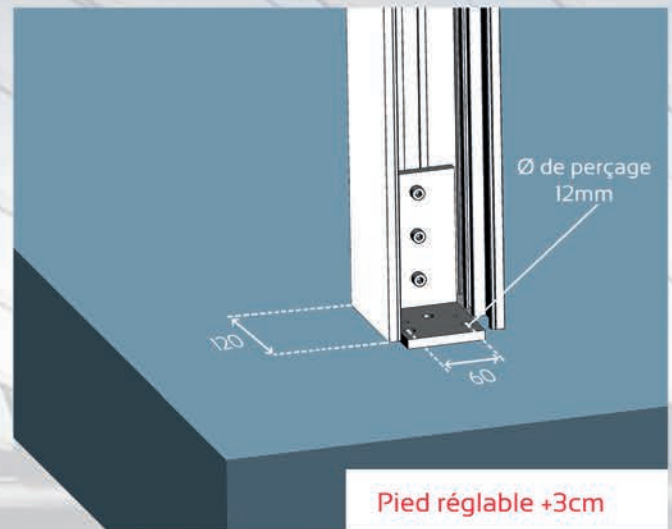

Télécommande

- Nombre de canaux : 6
- Possibilité de pilotage :
 - Ouverture / fermeture des lames
 - Eclairage LED
 - Store

Si plusieurs rangées de lames ou modules, vous pouvez créer des scénarios.

Par exemple : 1 canal pour les lames avant, 1 pour les lames arrières et 1 pour l'ensemble des lames.

EXEMPLES DE CONFIGURATIONS :



3 x 3 m
Autoportante



4,05 x 3 m
Autoportante

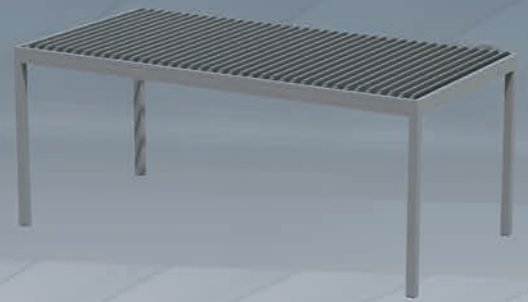

6 x 3 m
Autoportante



3 x 3 m
Murale

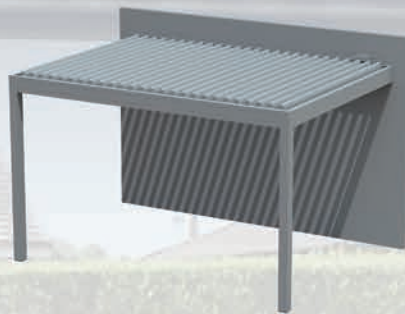

4,05 x 3 m
Murale



6 x 3 m
Murale

Hauteur : 2,50m Hauteur lames ouverte : 2,56m Hauteur hors tout : 2,64m
un raidisseur sera ajouté pour toutes largeurs > 4,05m

EXEMPLES D'ASSEMBLAGES

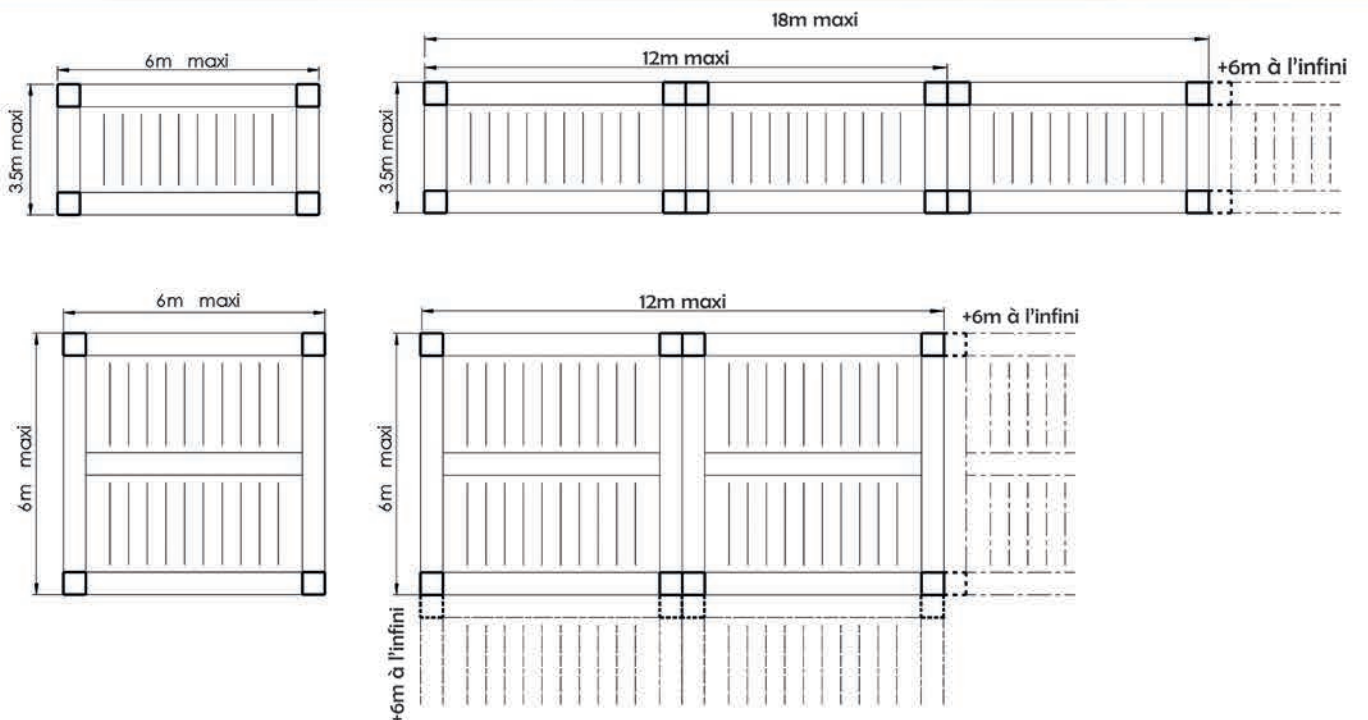

LES OPTIONS :

Eclairage LED

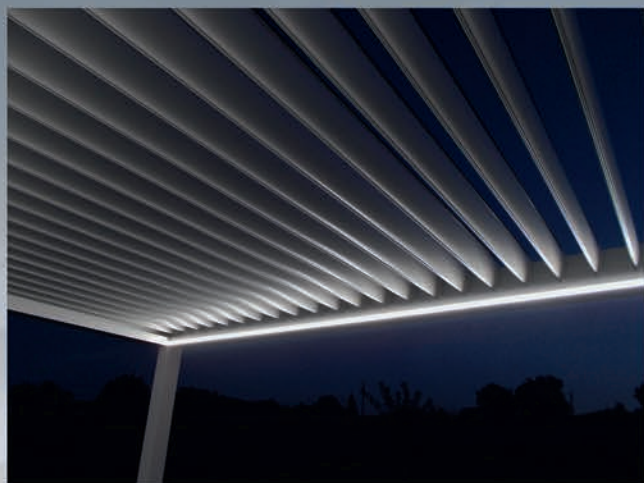

LED RGB 230/24 V

Structure : Flexible

Puissance : 14,4 watts/mètre
4000 K
1270 lm

Indice de protection : IP67

Utilisation via télécommande de la pergola

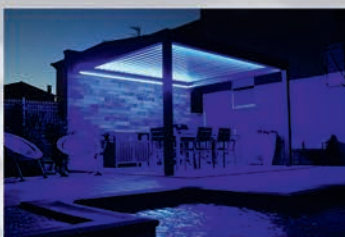

Position des bandeaux

Prof < 3,5



1 rangée de lames

Prof > 3,5

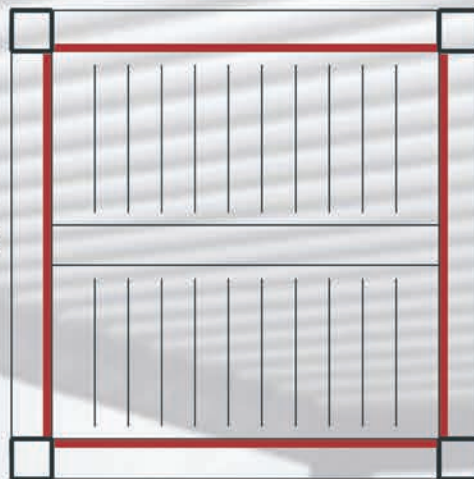

2 rangées de lames

Capteur Météo



Permet de gérer l'orientation des lames en fonction du vent, de la pluie, de la neige et du gel.

Cette option comprend :



Capteur de vent



Capteur de pluie



Capteur de température

LES OPTIONS :

Store zippé



Grammage de la toile : 525g/m²

Epaisseur : 0,75mm

Température : -30°C / +70°C

Coloris



Gris clair



Blanc



Gris foncé

Store façade en 2 parties avec poteau intermédiaire pour les pergolas d'une largeur supérieur à 4279mm (hors tout)

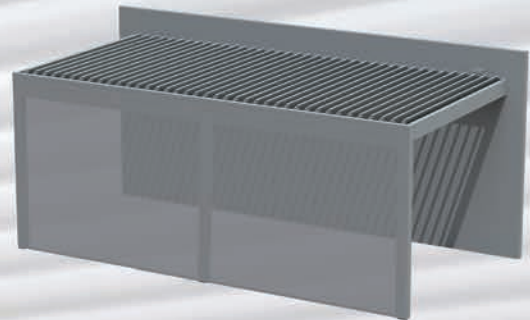
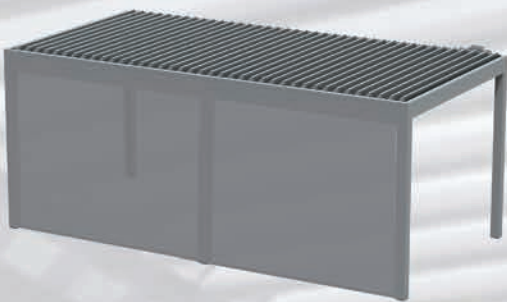

Télécommande pour bandeau LED

Les stores se manipulent à l'aide de la télécommande de la pergola.

Réglage sur les différents canaux.

Paroi vitrée



Verre trempé de 10 mm

5 parois coulissantes

5 panneaux en verre trempé 10 mm.

Les panneaux coulissent sur un rail bas en aluminium anodisé et sont guidés par un second rail haut avec loqueteau de fermeture droit et gauche.

QUELQUES REALISATIONS



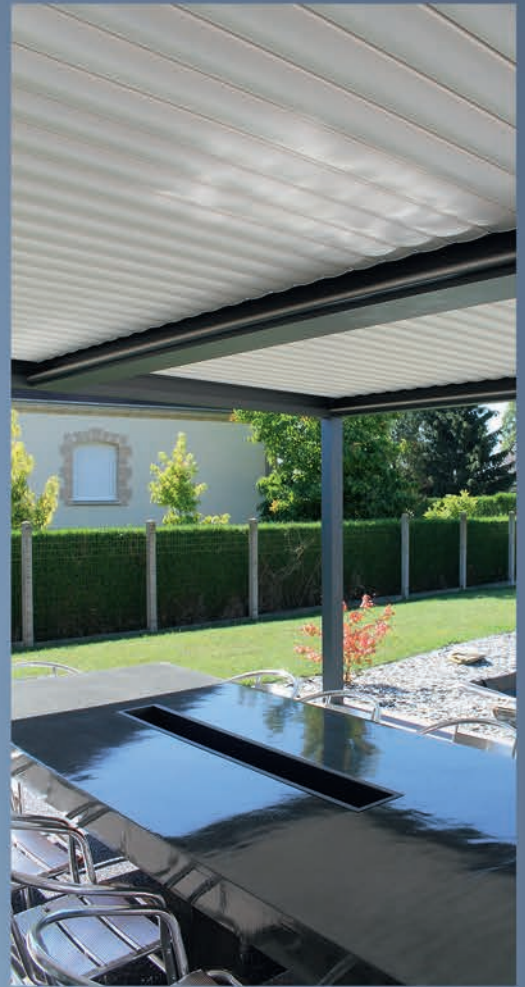

Photos non contractuelles



Pergola à toit fixe

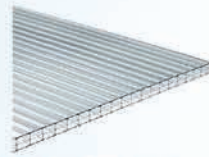

Polycarbonate
alvéolaire opaque 16mm

ou



Panneaux isolés
blanc 16mm

Dimensions

3,71x3 mètres / 4,92x3,08 mètres / 6,13x3,08 mètres
(Murale ou Autoportante)
Hauteur : 2,51m

Pas de sur mesure possible

Coloris standards

Structure:



Blanc 9010 mat



Gris 7016 sablé

Options

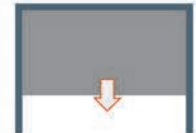

Store zippé
enroulable manuel

DES PROFILS ROBUSTES ET ESTHETIQUES :

Cadre

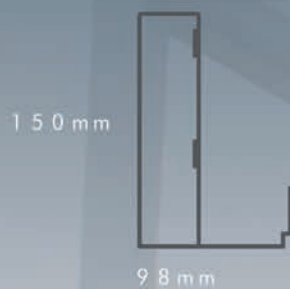

EP. 2,5 mm

Poteau

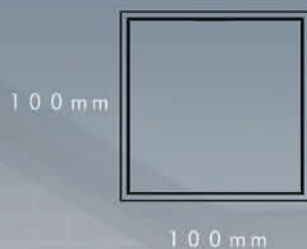

EP. 4 mm

Coiffe+2 joints



Panne



EP. 3 mm

FIXATION MURALE



FIXATION DES POTEAUX

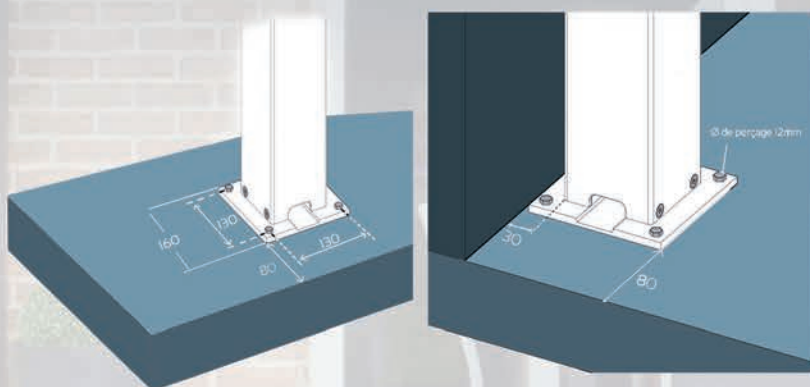

OPTIONS

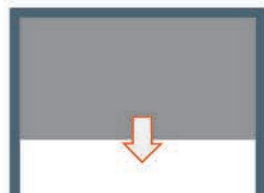

Store zippé
enroulable
par manivelle

Grammage de la toile 585g/m²

Epaisseur 0,74mm

Température -30°C / +70°C

Coloris standards:

 Gris clair

Coloris avec délais supplémentaire:

 Blanc

 Gris foncé

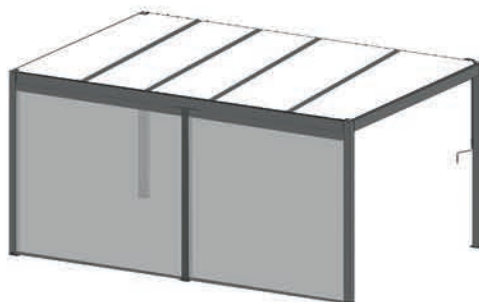
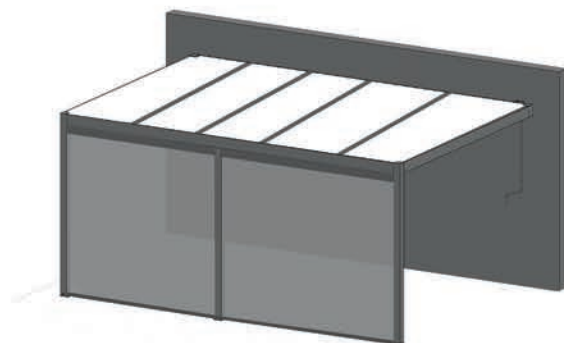

EXEMPLES DE CONFIGURATIONS :



3,71 x 3,08m
Autoportante



4,92 x 3,08m
Autoportante

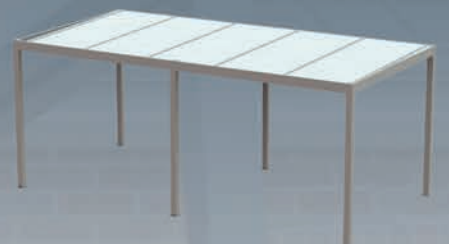

6,13 x 3,08m
Autoportante



3,71 x 3,08m
Murale



4,92 x 3,08m
Murale



6,13 x 3,08m
Murale

Hauteur hors tout : 2,51m

NOS REALISATIONS



Photos non contractuelles

Tél : 03.60.48.15.01
 Fax : 03.23.98.04.42
 Mail : devis@orialpro.fr

PERGOLA 'MARBELLA'
 MODÈLE EN ALUMINIUM A LAMES ORIENTABLES 'BIOCLIMATIQUE'

Entreprise :

Adresse :

Ville : CP :

Tél : Fax :

Mail :@.....



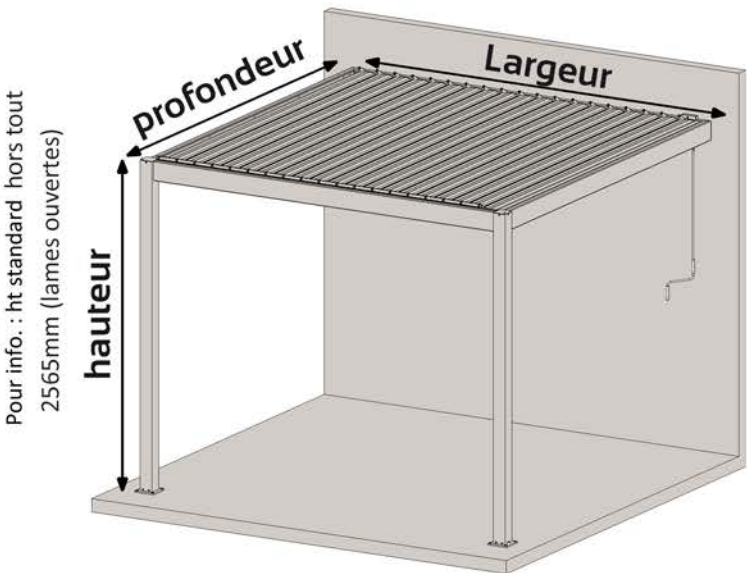

Tampon :

Personne en charge du dossier :

Référence du chantier :



Pour information : commande d'ouverture des lames par manivelle

AUTOPORTANTE	MURALE	OPTIONS
 <input type="checkbox"/> Dim. 4,13 x 3,50 x ht 2,50	 <input type="checkbox"/> Dim. 4,13 x 3,50 x ht 2,50	<input type="checkbox"/> Option éclairage (Leds RGB, 2 bandeaux) <input type="checkbox"/> Store zippé manuel <input type="checkbox"/> façade <input type="checkbox"/> latéral <input type="checkbox"/> Lot de 6 cales de 5mm <input type="checkbox"/> Lot de 6 cales de 10mm
 <input type="checkbox"/> Dim. 5,18 x 3,50 x ht 2,50 Sur mesure(max 10.36 x3.50)	 <input type="checkbox"/> Dim. 5,18 x 3,50 x ht 2,50 Sur mesure(max 10.36 x3.50)	

Structure : BLANC RAL 9010 MAT GRIS RAL 7016 SABLÉ AUTRES (p.6) **Lames:** BLANC RAL 9010 MAT

Configuration chantier :

Tél : 03.60.48.15.01
 Fax : 03.23.98.04.42
 Mail : devis@orialpro.fr

PERGOLA 'CASTILLE'

MODELE EN ALUMINIUM TOITURE TERRASSE





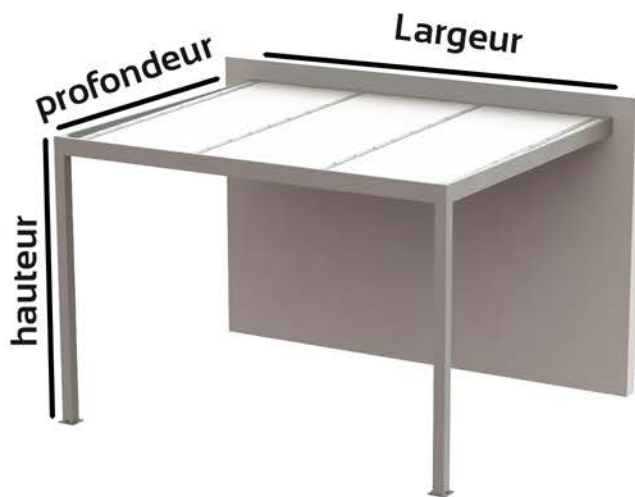

Entreprise :

 Adresse :
 Ville : CP :
 Tél : Fax :
 Mail :
@.....
 Tampon :

 Personne en charge du dossier :
 Référence du chantier :

Pour info. : ht standard hors tout
 2510mm



AUTOPORTANTE	MURALE	OPTIONS
 <input type="checkbox"/> Dim. 3,71 x 3,08 x ht 2,51	 <input type="checkbox"/> Dim. 3,71 x 3,08 x ht 2,51	<input type="checkbox"/> Store zippé manuel <input type="checkbox"/> façade <input type="checkbox"/> latéral Toiture : <input type="checkbox"/> Toiture Polycarbonate <input type="checkbox"/> Panneaux isolés
 <input type="checkbox"/> Dim. 4,92 x 3,08 x ht 2,51	 <input type="checkbox"/> Dim. 4,92 x 3,08 x ht 2,51	
 <input type="checkbox"/> Dim. 6,13 x 3,08 x ht 2,51	 <input type="checkbox"/> Dim. 6,13 x 3,08 x ht 2,51	

o **Couleur :** BLANC RAL 9010 MAT GRIS RAL 7016 SABLÉ

Configuration chantier :

Tableau de synthèse pergola

	Pergola Marbella	Pergola Panama	Pergola Castille
Livraison domicile	●	●	●
Toiture			
Polycarbonate alvéolaire opaque			●
Panneaux isolés blanc			●
Lames			
Orientation des lames	●	●	
Manoeuvre des lames	manuelle	motorisée	
Version de pose			
Murale	●	●	●
Autoportante	●	●	●
Dimensions			
4,13 x 3,50	●		
5,18 x 3,50	●		
3x3		●	
4,05 x 3		●	
6 x 3		●	
3,71 x 3,08			●
4,92 x 3,08			●
6,13 x 3,08			●
Sur mesure	●	●	
Coloris Structure			
Gris 7016 sablé	●	●	●
Blanc 9010 mat	●	●	●
Sur mesure		●	
Coloris lames			
Blanc 9010 mat	●	●	
Sur mesure	●	●	
En Options			
Store zip manuel	●		●
Store zip motorisé		●	
Eclairage LED	● RGB	● RGB	
Paroi coulissante verre		●	
Capteur Météo (vent, pluie, neige, gel)		●	

Obtenez votre devis et vos plans
grâce à notre configuration en ligne

www.orientalblinds.com

PERGOLA BÉLIZE

Chantier référence :
Version Autoportante

Devis N°:

Dimensions :

Longueur = mm
Largeur = mm
Hauteur = mm

Finition :

- Structure en RAL:
- Lames en RAL 9010 Mat

Options :

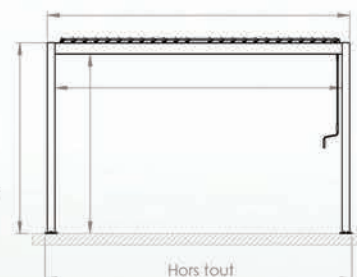

Bon pour accord

Date :
Signature/tampon :

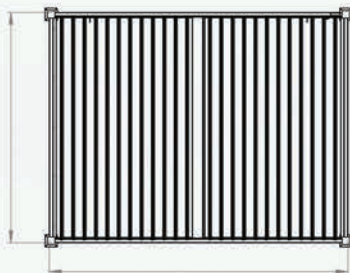

otre plan très rapidement
figurateur en ligne

iasun.fr



**Abritez vos véhicules
grâce à nos carports
aluminium**







Choisissez votre toiture :

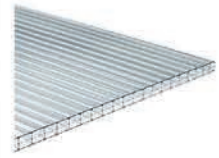

Polycarbonate
alvéolaire opale 16mm

ou



Panneaux isolés
blanc 16mm

Dimensions

4,92 x 3,08 mètres / 6,13 x 3,08 mètres
(Murale ou Autoportante)
Hauteur: 2,51m

Pas de sur mesure possible

Coloris standards

Structure:



Blanc 9010 mat



Gris 7016 sablé

DES PROFILS ROBUSTES ET ESTHETIQUES :

Cadre

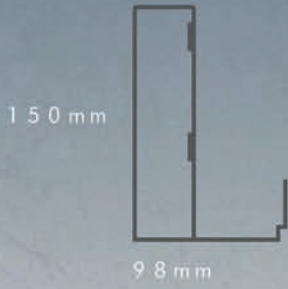

EP. 2,5 mm

Poteau

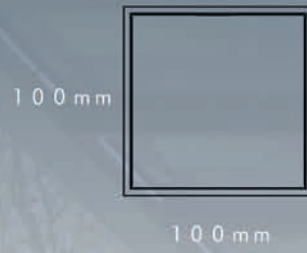

EP. 4 mm

Coiffe+2 joints

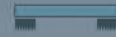

Panne



EP. 3 mm

FIXATION MURALE

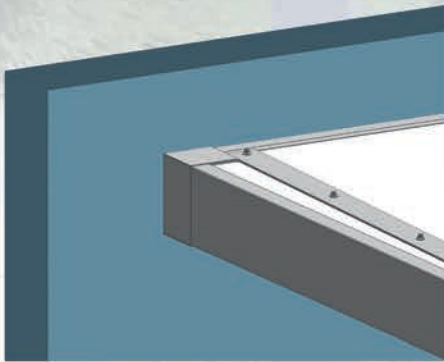

FIXATION AUTOPORTANTE

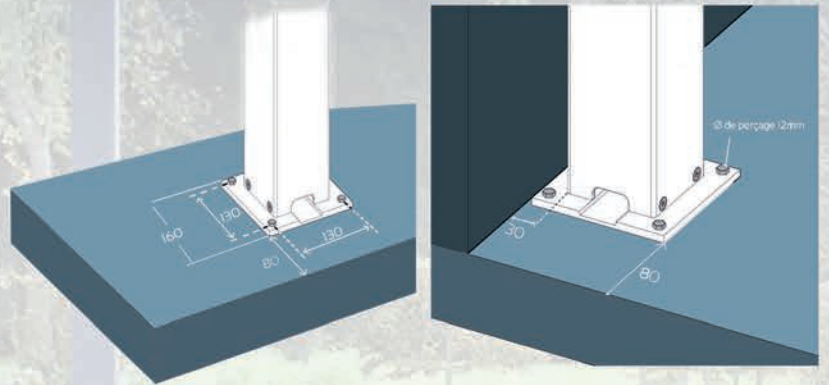

EXEMPLES DE CONFIGURATIONS :



4,92 x 3,08m
Autoportante



6,13 x 3,08m
Autoportante



4,92 x 3,08m
Murale



6,13 x 3,08m
Murale

Dimensions de passage pour votre véhicule:

Longueur : 4,92m Largeur : 2,88m

Longueur : 6,13m Largeur : 2,88m

Hauteur : 2,36m

Hauteur (hors tout) : 2,51m

Hauteur : 2,36m

NOS REALISATIONS



Photos non contractuelles



Carport C210

Choisissez votre toiture :

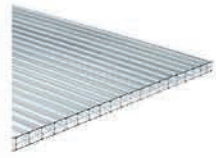

Polycarbonate
alvéolaire opale 16mm

ou



Panneaux isolés
blanc 16mm

Dimensions

5,15 x 3 mètres / 6,36 x 3 mètres
(Murale ou Autoportante)
Hauteur: 2,50m

**Sur mesure possible
hauteur 3m Max.**

Coloris standards

Structure:



Blanc 9010 mat



Gris 7016 sablé

Options



Eclairage
avec détecteur
de présence
blanc



Paroi arrière
aluminium



Paroi latérale
aluminium

Photos non contractuelles

DES PROFILS ROBUSTES ET ESTHETIQUES :

Cadre

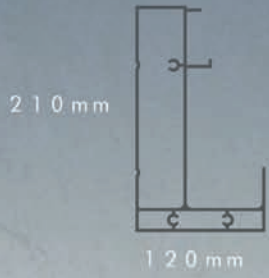

EP. 2,5 mm

Poteau



EP. 5 mm

Coiffe+2 joints

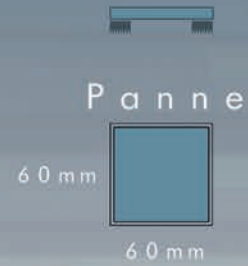

Panne



60 mm

EP. 3 mm

FIXATION MURALE

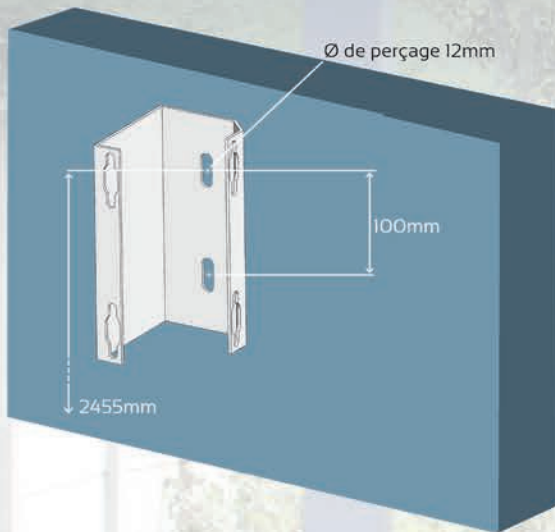

FIXATION AUTOPORTANTE

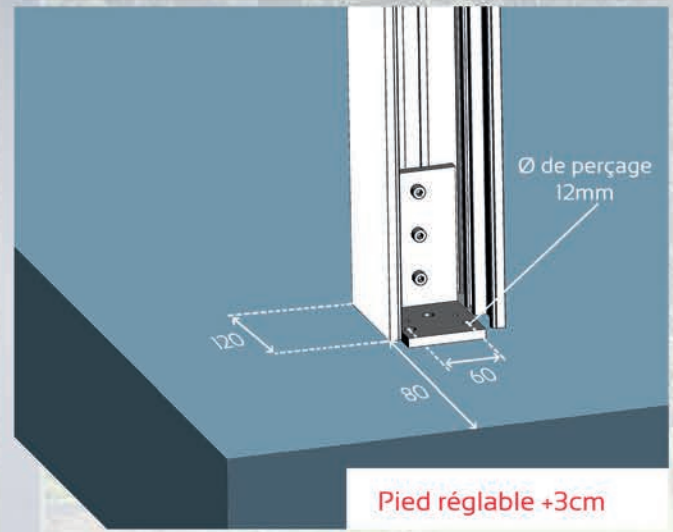

OPTIONS



Eclairage avec détecteur de présence

IP 65

Puissance : 12W

Blanc neutre 4000k



Paroi arrière aluminium

100 % Aluminium

Section des lames : 157 x 15mm

Lames réversibles (2 motifs)



Paroi latérale aluminium

100 % Aluminium

Section des lames : 157 x 15mm

Lames réversibles (2 motifs)

EXEMPLES DE CONFIGURATIONS :



5,15 x 3m
Autoportante



6,36 x 3m
Autoportante



5,15 x 3m
Murale



6,36 x 3m
Murale

Dimensions de passage pour votre véhicule:

C210 5,15m : Largeur : 2,76m

Hauteur : 2,29m

Hauteur : 2,51m

C210 6,36m : Largeur : 2,76m

Hauteur : 2,29m



Choisissez votre toiture :



Polycarbonate alvéolaire opale 16mm

ou



Panneaux isolés blanc 16mm



Dimensions

6,36 x 3 mètres

Autoportant uniquement

Hauteur: 2,50m

Dimensions de passage pour votre véhicule :

Longueur : 5,15m

Largeur : 2,76m

Hauteur : 2,29m

Coloris standards

Structure:  Gris 7016 sablé

Options



Eclairage avec détecteur de présence blanc



Paroi latérale aluminium

Tableau de synthèse carport

	Carport C-150	Carport C-210	Carport C-210 avec local technique
Livraison domicile	●	●	●
Toiture			
Polycarbonate alvéolaire opaque	●	●	●
Panneaux isolés blanc	●	●	●
Version de pose			
Murale	●	●	
Autoportante	●	●	●
Dimensions			
4,92 x 3,08 mètres	●		
6,13 x 3,08 mètres	●		
5,15 x 3 mètres		●	
6,36 x 3 mètres		●	●
Sur mesure		●	
Coloris Structure			
Gris 7016 sablé	●	●	●
Blanc 9010 mat	●	●	
En Options			
Eclairage avec détecteur de présence		●	●
Paroi aluminium arrière		●	
Paroi aluminium latérale		●	●



Retrouvez les présentations et vidéos de montages de nos produits sur notre chaîne youtube : Oriasun

Chiffrez directement votre chantier



Si vous n'avez pas encore accès à notre bibliothèque , envoyez votre demande service-commercial@orialpro.fr





Brise soleil

Dimensions

1440 x 751 mm ou 2860 x 751 mm en standard
et **sur mesure possible**



Longueur sur mesure possible à l'infini
en assemblant les modules

Coloris standards

Structure:  Gris 7016 sablé

 Sur mesure
(selon RAI page.6)

Caractéristiques :

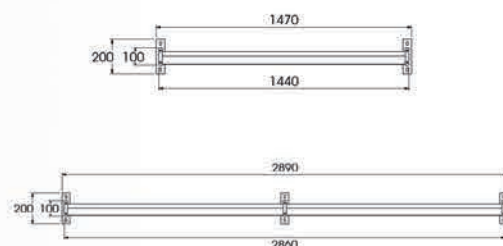

Nos réalisations

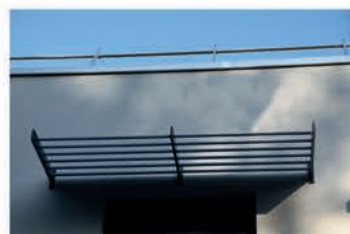

Photos non contractuelles

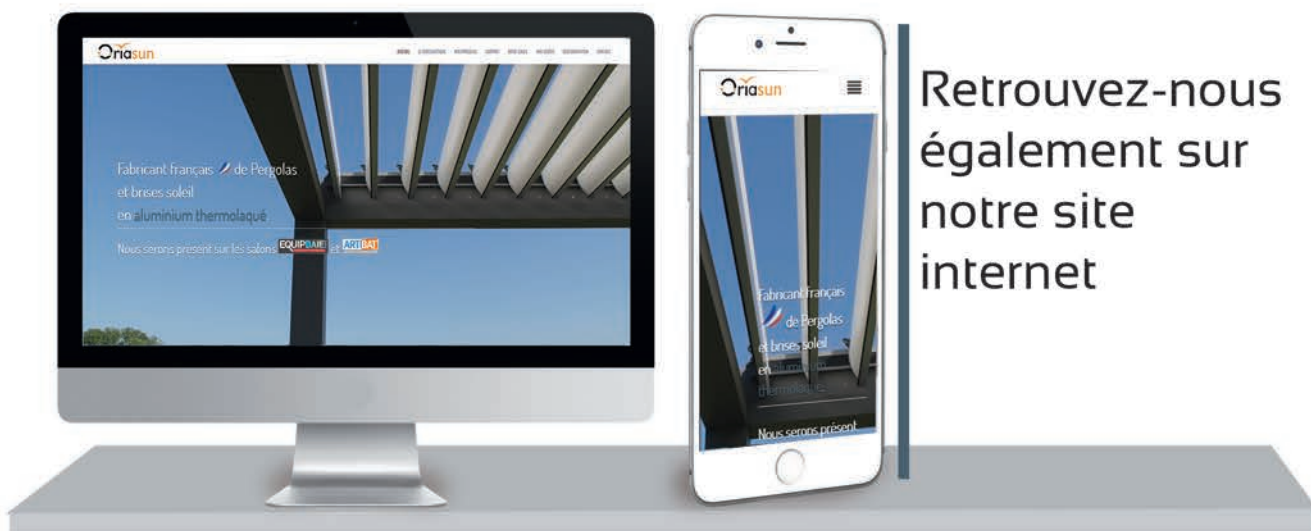

Retrouvez-nous également sur notre site internet

www.oriasun.fr

Documentations



Fiches Techniques



Vidéos

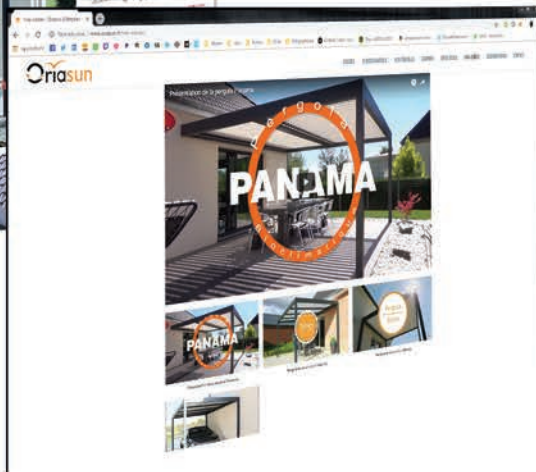

Besoin d'un conseil, d'un devis ou autres ?
Contactez un de nos collaborateurs ci-dessous.

Sylvie :

Assistance commerciale, expédition



service-commercial@orialpro.fr



03.23.91.35.63

Sébastien :

Devis



devis@orialpro.fr



03.60.48.15.01

Maxime :

Service après-vente



sav@orialpro.fr



03.60.73.60.04

Angélique :

Commande et règlement



angelique@orialpro.fr

Une équipe de commerciaux terrain est à votre disposition :
consultez-nous pour leurs coordonnées

Conditions commerciales

Frais de port:

Franco à partir de 1 500 euros d'achat HT
De 0 à 1 499€ d'achat HT, frais de port de 70€ HT

Frais administratifs:

Des frais de 30€ HT seront appliqués pour toutes commandes < 300€ HT d'achat

Conditions commerciales:

acompte de 40% à la commande

Le solde à 30 jours fin de mois selon accord SFAC



CARPORTS



BRISE - SOLEIL

Retrouvez aussi nos gammes

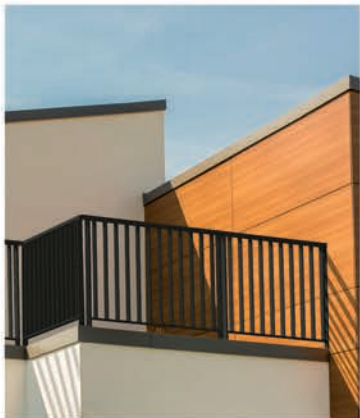

Oriabal
www.oriabal.fr



OriaStep
Escaliers contemporains
www.oriastep.fr



TASAE
www.tasae.fr

125 rue de guise
02500 HIRSON
France

Téléphone : +33(0)3 23 91 35 63

Fax : +33(0)3 23 98 04 42

Site : www.oriasun.fr

Mail : service-commerciale@orialpro.fr
sav@orialpro.fr

